

# edilportale<sup>®</sup>

## TOUR 2016

Efficienza energetica e comfort abitativo  
Tecnologie non invasive e sicurezza  
Sostenibilità economica e ambientale

in collaborazione con

**VELUX<sup>®</sup>**



L'Aquila, 23 Marzo 2016

**Alubel, sistemi per la riqualificazione degli edifici**

**Arch. Matteo Minelli**

**PRIMA**



**DOPO**





## DATI TECNICI

- *S. 25 mm*
- *H. 500 mm*
- *L. a misura*

## MATERIALI

- *Alluminio  
preverniciato*
- *Poliuretano espanso  
ad alta densità*



## PRINCIPALI CARATTERISTICHE

- FINITURA LISCIA
- FISSAGGIO NASCOSTO
- AMPIA SCELTA DI COLORI
- FACILE DA INSTALLARE
- LEGGERO E MANEGGEVOLE
- IDEALE IN CASO DI RIQUALIFICAZIONE EDILIZIA



## LAVORAZIONI

### PANEL EDGING

CHIUSURA LATERALE



### TAGLIO A 45°

REALIZZAZIONE ANGOLO





## ACCESSORI

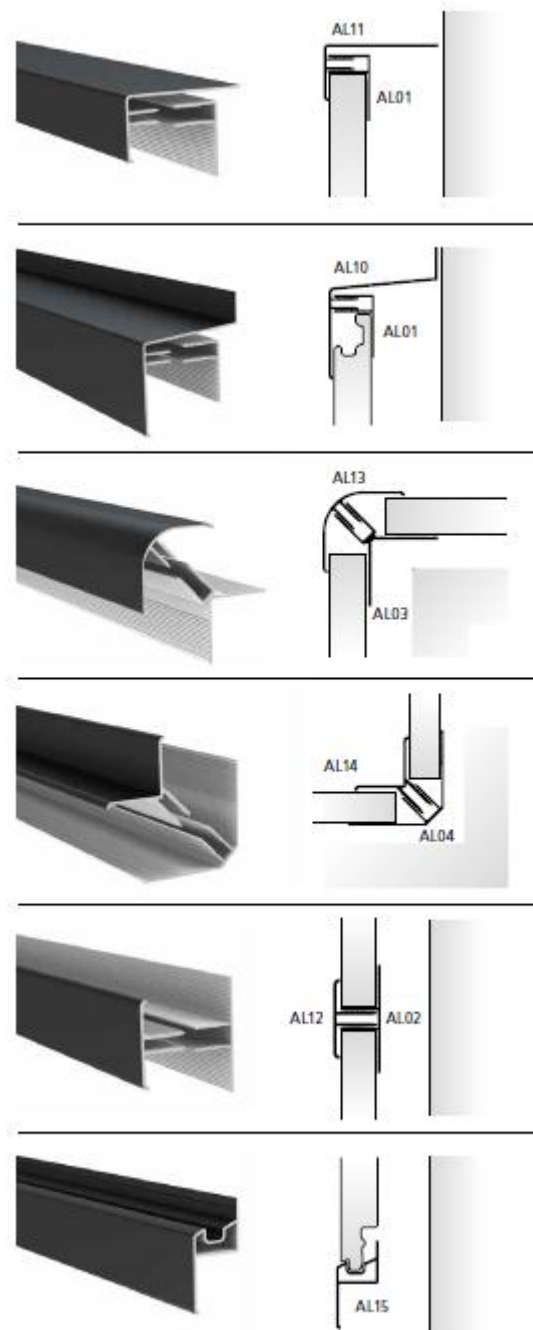
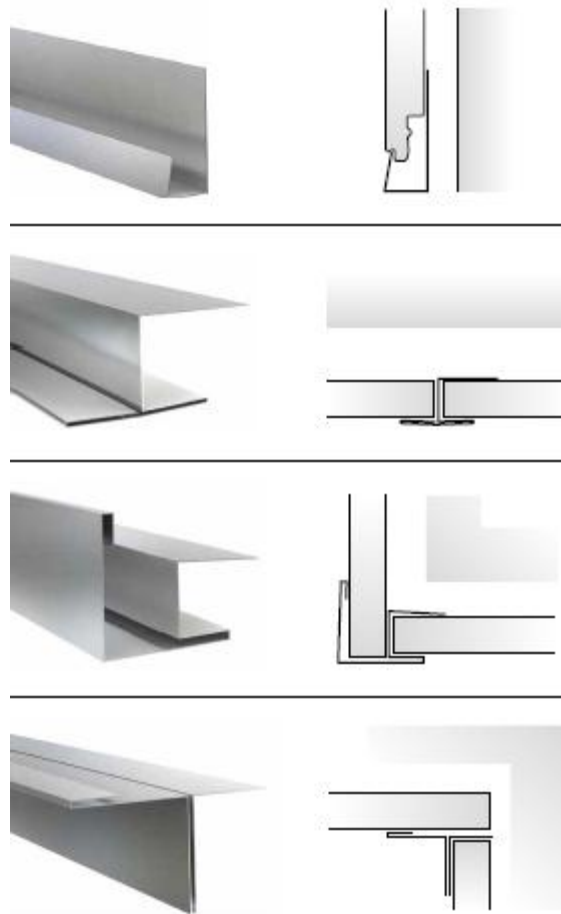

## *Case history*

Riqualificazione stabilimento produttivo  
**CSO Italia – Scandicci (FI)**

- **Progettista:**  
Arch. Silvia Nanni - San Casciano Val di Pesa (FI)
- **Ditta installatrice:**  
Coperture Cappelletti Daniele e Figli S.R.L. di Prato (PO)





## DEMOLIZIONE ?

**NO, GRAZIE.**

**PERCHE' ?**

- ECCESSIVA BUROCRAZIA
- BASSA SOSTENIBILITA'

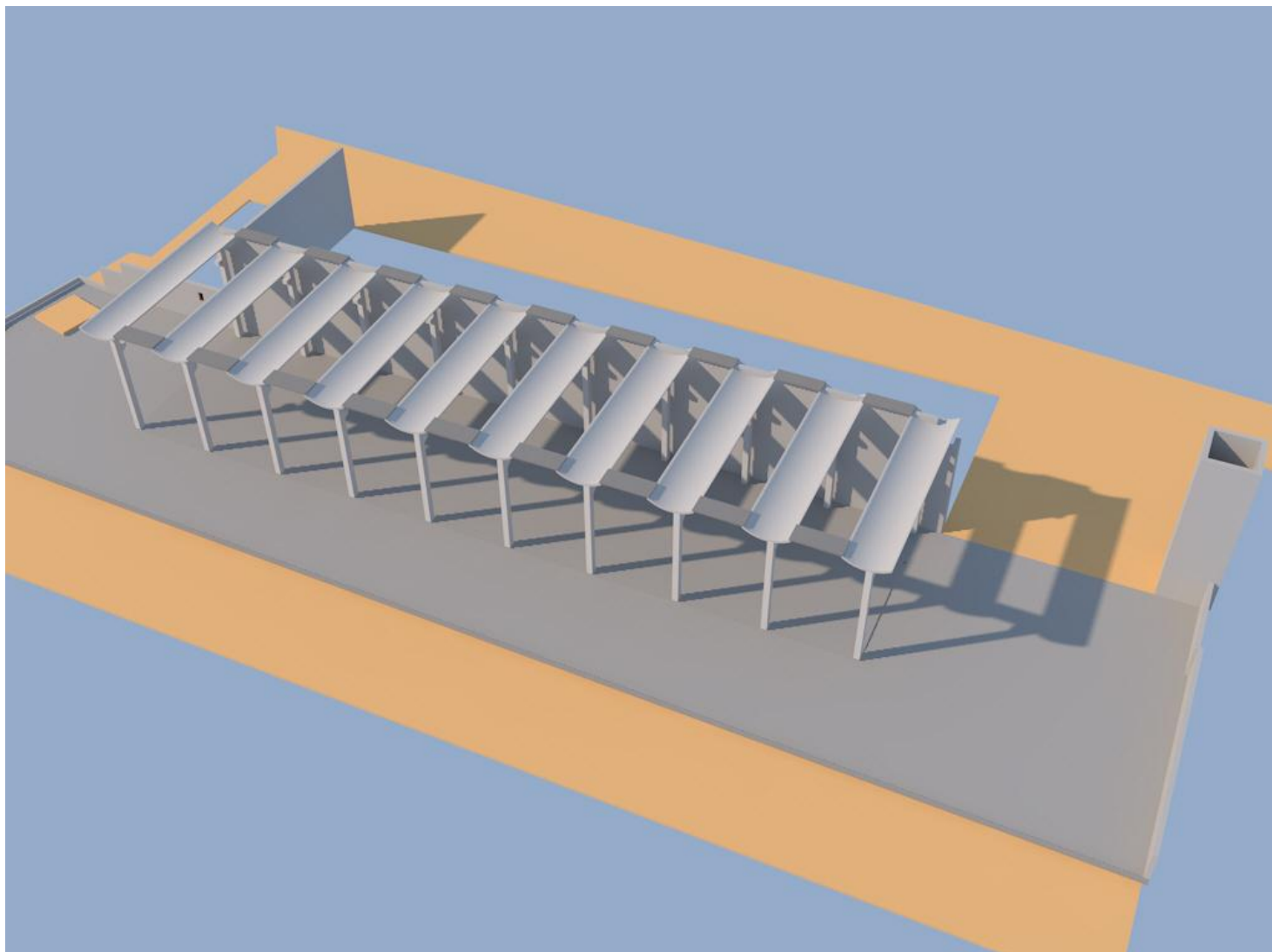

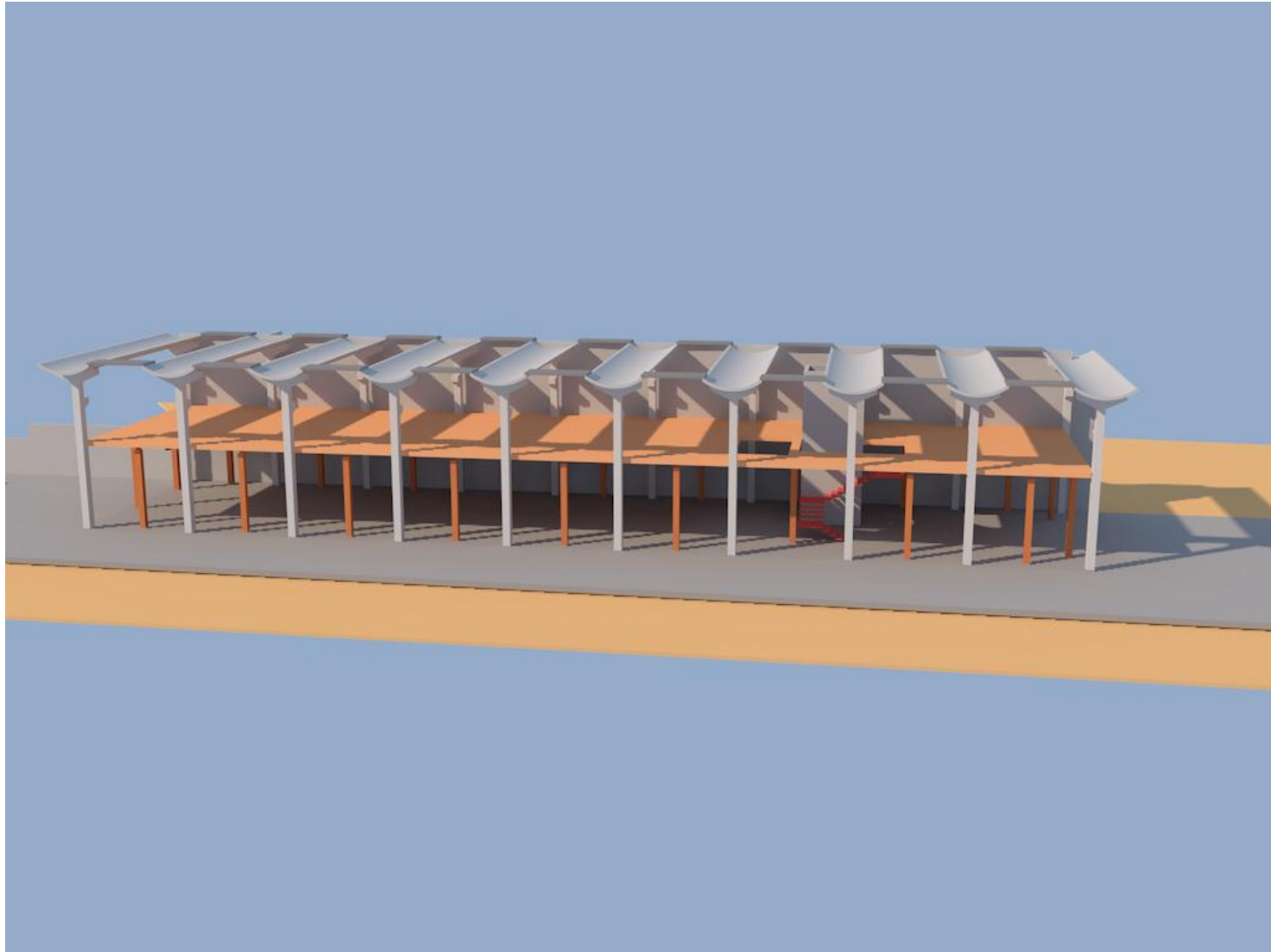



**PROGETTO  
COPERTURA**

**CARATTERISTICHE TERMICHE/IGROMETRICHE DEI COMPONENTI OPACI DELL'INVOLUCRO EDILIZIO**

TIPO DI STRUTTURA Copertura piana pannello sandwich  
cod 630 SOF

Massa [kg/m <sup>2</sup> ]	19,6	Capacità [kJ/m <sup>2</sup> K]	12,7	Type Ashrae			1		
N	Descrizione strato (dall'interno verso l'esterno)		s (m)	λ (W/mK)	C (W/m <sup>2</sup> K)	ρ (kg/m <sup>3</sup> )	δa 10 <sup>12</sup> (kg/m <sup>2</sup> Pa)	δu 10 <sup>12</sup> (kg/m <sup>2</sup> Pa)	R (m <sup>2</sup> K/W)
1	Lamiera		0,0010	17,000	17000,00	8000	1,0000	1,0000	0,000
2	Poliuretano espanso a celle chiuse da 30 Kg/mc in lastre da blocchi espansi in continuo per strutture orizzontali		0,1200	0,032	0,27	30	0,2000	0,2000	3,750
3	Lamiera		0,0010	17,000	17000,00	8000	1,0000	1,0000	0,000
SPESSORE TOTALE [m]			0,1220						

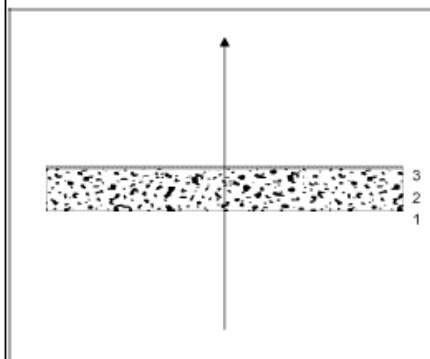

Conduttanza unitaria superficie interna	9	Resistenza unitaria superficie interna	0,107
---	---	--	-------

Conduttanza unitaria superficie esterna	23	Resistenza unitaria superficie esterna	0,043
---	----	--	-------

TRASMITTANZA TOTALE[W/m <sup>2</sup> K]	0,256	RESISTENZA TERMICA TOTALE[m <sup>2</sup> K/W]	3,900
---	-------	---	-------

**VERIFICA IGROMETRICA — CONDIZIONI AL CONTERNO**

CONDIZIONE	Ti(°C)	Pi(Pa)	Te(°C)	Pe(Pa)
INVERNALE: gennaio	20,0	1520	0,0	549
ESTIVA: agosto	24,0	2387	24,0	2089

<input checked="" type="checkbox"/>	La struttura non è soggetta a fenomeni di condensa interstiziale; la differenza minima di pressione tra quella di saturazione e quella reale è pari a [Pa]	70
<input type="checkbox"/>	La struttura è soggetta a fenomeni di condensa; la quantità stagionale di condensato è pari a [kg/m <sup>2</sup> ] (ammissibile ed evaporabile nella stagione estiva)	
<input checked="" type="checkbox"/>	La struttura non è soggetta a fenomeni di condensa superficiale; la differenza minima di pressione tra quella di saturazione e quella reale è pari a [Pa]	741

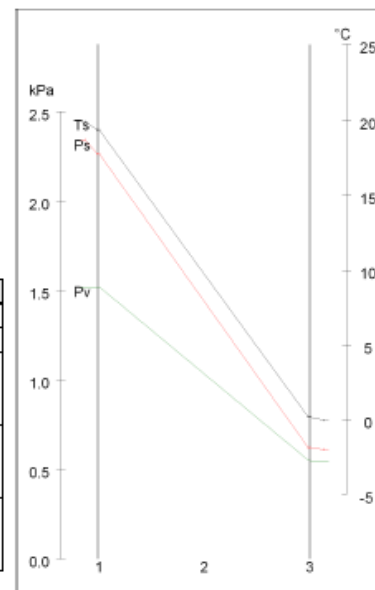

**EASYWAND**



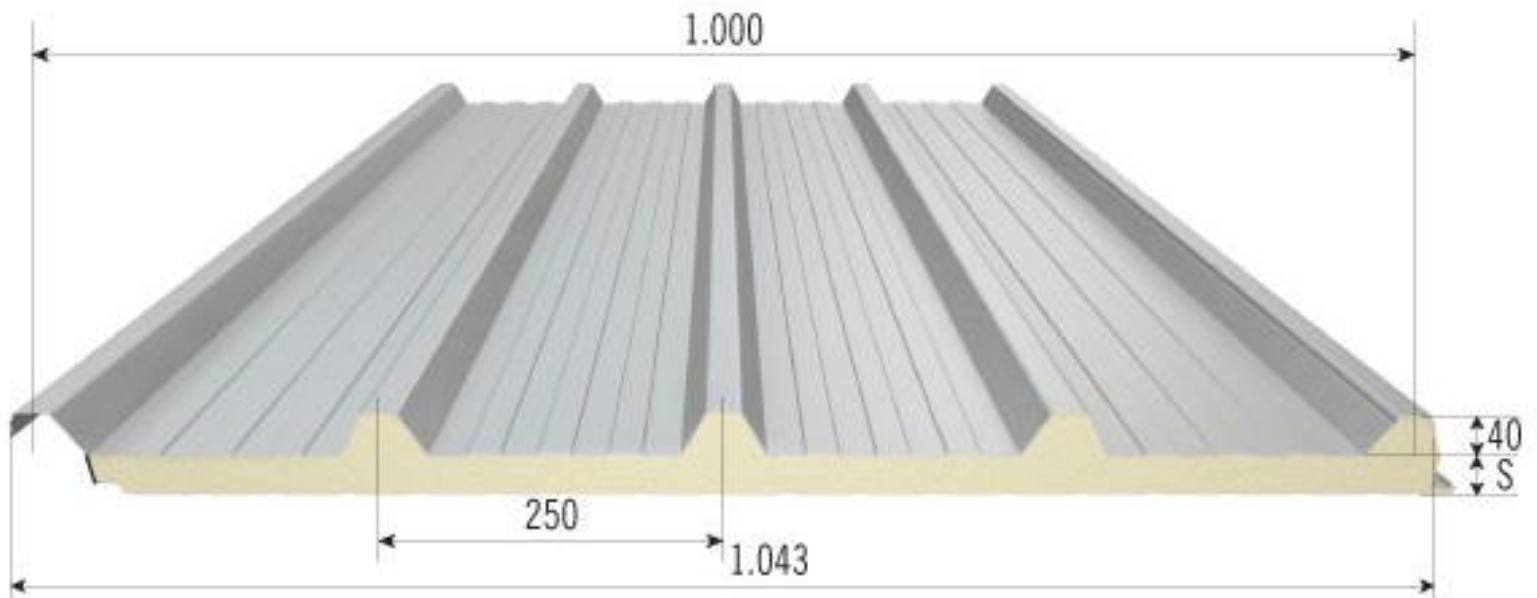















TIPO DI STRUTTURA *Muratura isolata a cappotto*  
cod 154 P.E

Massa [kg/m <sup>2</sup> ]	464.5	Capacità [kJ/m <sup>2</sup> K]	390.8	Type Ashrae		33			
N	Descrizione strato (dall'interno verso l'esterno)		s (m)	λ (W/mK)	C (W/m <sup>2</sup> K)	ρ (kg/m <sup>3</sup> )	δa 10 <sup>12</sup> (kg/m <sup>2</sup> Pa)	δu 10 <sup>12</sup> (kg/m <sup>2</sup> Pa)	R (m <sup>2</sup> K/W)
1	Laterizi per pareti esterne (mattono pieno)		0,2500	0,800	3,20	1800	20,8400	20,8400	0,312
2	Polistirene espanso		0,1000	0,031	0,31	15	10,0000	10,0000	3,228
3	Intonaco plastico per isolamenti a cappotto (permeabilità garantita)		0,0100	0,300	30,00	1300	6,2500	6,2500	0,033
SPESSORE TOTALE [m]			0,3600						

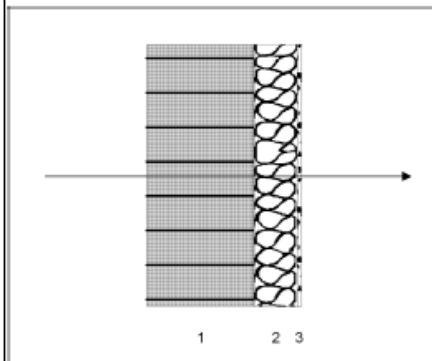

Conduttanza unitaria superficie interna	8	Resistenza unitaria superficie interna	0,123
---	---	--	-------

Conduttanza unitaria superficie esterna	23	Resistenza unitaria superficie esterna	0,043
---	----	--	-------

TRASMITTANZA TOTALE [W/m <sup>2</sup> K]	0,268	RESISTENZA TERMICA TOTALE [m <sup>2</sup> K/W]	3,738
--	-------	--	-------

# PROGETTO FACCIATA

## VERIFICA IGROMETRICA — CONDIZIONI AL CONTORNO

CONDIZIONE	Ti(°C)	Pi(Pa)	Te(°C)	Pe(Pa)
INVERNALE: gennaio	20.0	1520	0.0	549
ESTIVA: agosto	20.0	1870	20.0	1637
<input checked="" type="checkbox"/> La struttura non è soggetta a fenomeni di condensa interstiziale; la differenza minima di pressione tra quella di saturazione e quella reale è pari a [Pa]				14
<input type="checkbox"/> La struttura è soggetta a fenomeni di condensa; la quantità stagionale di condensato è pari a [kg/m <sup>2</sup> ] (ammissibile ed evaporabile nella stagione estiva)				
<input checked="" type="checkbox"/> La struttura non è soggetta a fenomeni di condensa superficiale; la differenza minima di pressione tra quella di saturazione e quella reale è pari a [Pa]				725

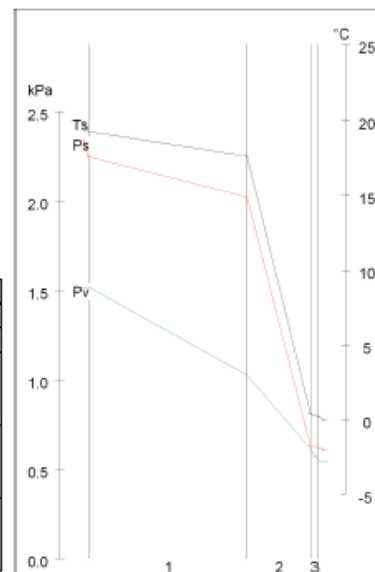

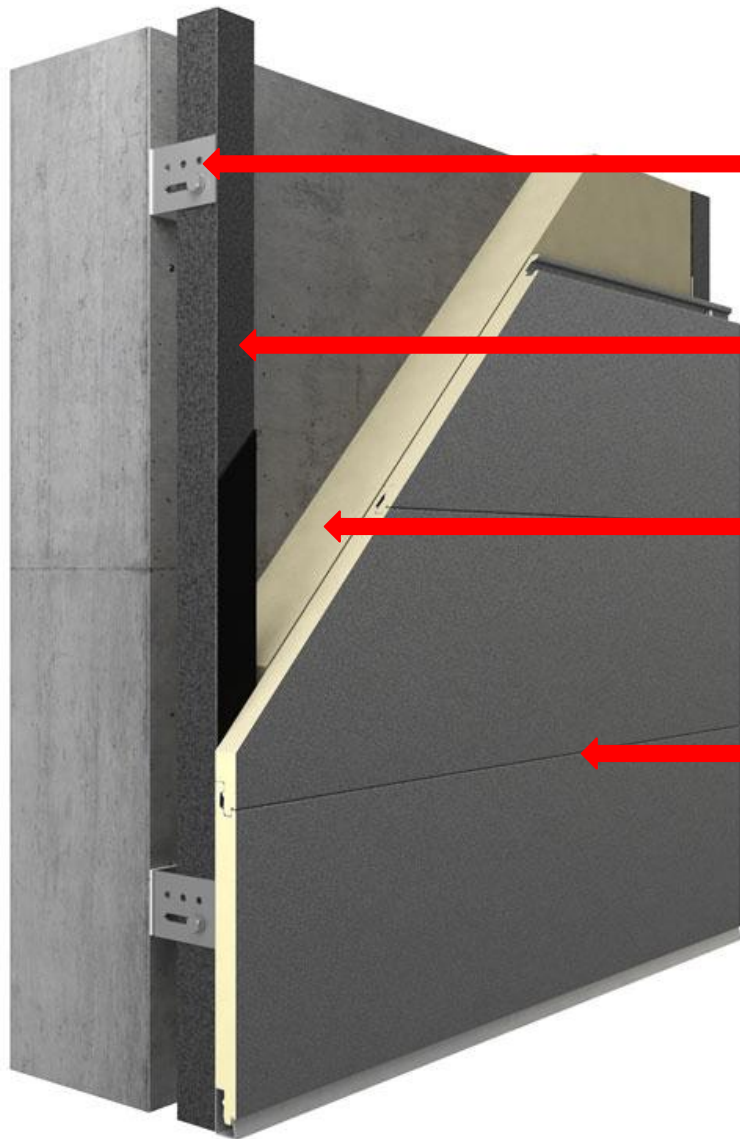

- Staffe di supporto asolate

- Profili di ancoraggio

- Coibentazione in pannelli di polistirene estruso

- Pannelli Easywand





























**PRIMA**



**DOPO**





**PRIMA**



**DOPO**



**GRAZIE E  
BUON LAVORO !**

